



RMI RATERMANN

MANUFACTURING, INC.

Largest Selection of Cryogenic and Compressed Gas Equipment & Supplies

Fall Catalog ■ Starts October 25 ■ Ends December 31, 2008

Meca-Inox

- Manual Ball Valve
- Actuated Ball Valve

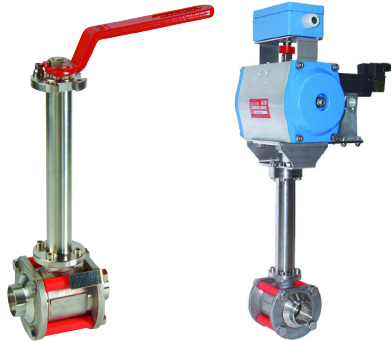

Cryogenic Ball Valves

see page 4

NOW AVAILABLE



See Our Complete Line of Liquid Level Gauges

Bulk Tank Gauges

see page 5

See Our Complete Line of Lab Dewar Distribution Resale Program

- Top Grade Product with Great Pricing
- Customized Cover to Promote Your Company



Lab Dewars

see page 3

New Product Dewar Mat Water Disposal System

No More Water on the Floor

- for Labs
- Clean Rooms
- Anywhere You Need Water Removed



Dewar Mat

see page 2

High Pressure Hose Designed for Laser Service



Check out the website

High Pressure Hose

see page 13

The **HOSE BUILDER**

4 Easy Steps to Layout the Hose You Need!

Promotion on Cylinder 6 & 12 & 16 Pack Cradles

6 & 12 Pack Cradles

see page 15



A New Way to Deliver High Pressure Tanks

- Route Truck Cylinder Delivery Truck



Call for more information patent pending

Collar Color Chart

pages 8 & 9



Pt # C1-DG



Pt # RC-LB



Pt # SQ-B



C1-CW-DB



Pt # C3-O



Pt # C-4-R



Pt # C2-P



Pt # AC-BR



Pt # C2-LR



Pt # C1-LR

High-Performance Lubricant/Sealant

Multi-Purpose Silicone/PTFE



This Product is Not Compatible for Oxygen – Do Not Use this Product with Oxygen

MPT Silicone/PTFE

Pt #	Description
HP-LS-2OZ	High Performance Lubricant/Sealant 2 oz. Jar
HP-LS-8OZ	High Performance Lubricant/Sealant 8 oz. Tube
HP-LS-16OZ	High Performance Lubricant/Sealant 16 oz. Jar

Multi-Purpose Grease

Molybdenum/PTFE

This Product is Not Compatible for Oxygen – Do Not Use this Product with Oxygen

MPT Moly PTFE

Pt #	Description
MPG-12CART	Multi-Purpose Grease 12 oz. Cartridge
MPG-14OZ	Multi-Purpose Grease 14 oz. Jar
CART-GUN	Grease Gun H.D.

Dewar Mat

Ratermann's Dewar Mats are used for labs, FAB, or any environment where you need to contain the condensation from a Dewar. Stop puddles from creating unsafe and messy floors.

Features

- Keeps a safe, clean environment
- Designed for 160, 180 & 200 liter size Dewar's filled with either liquid LN2, Argon, or CO2
- Protects the floor from cylinder damage

Pump water away, either to a sink, drain, or other receptacle to distances as far as 150 feet, or as high as 15 feet

UL listed 110 volt pump with built in float sensor turns pump on and off as needed to reduce water build up.

Dewar Mat

Pt #	Description
DEW-WM1	Water Mat Catcher
DEW-PUMP1	110V Deluxe Pump
DEW-T100	Tubing – 100 foot roll



Pumps water away, either to a sink, drain, or other receptacle

Bulk Propane Quick Fill

The QF-PRO134 features a sleeve actuated design for fast connect and disconnect to standard valves used on 20, 33 and 43 Motor Fuel / Forklift and Bulk "Bob Tail" Tank Filling cylinders.



Pt # QF-PRO134



Features & Benefits for Bulk and OPD Propane Quick Fill

- Compact, lightweight and sleeve actuation ensures easy connections
- Internal shut-off minimizes venting to atmosphere and eliminates need for inline external shut-off valve – <4cc for Pt # QF-PRO134 and <2cc for Pt # QF-PRO-OPD
- Meets clean air environmental requirements of propane vented upon disconnect
- Unique gripping design minimizes accidental disconnect under pressure

OPD Propane Cylinder Quick Fill

The QF-PRO-OPD features sleeve actuated technology for quick and easy connections for optimum filling of OPD Cylinder Filling Applications.

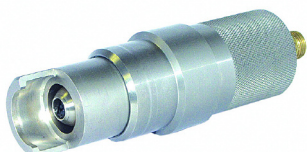

Pt # QF-PRO-OPD



Liquid Nitrogen Container

Ratermann Manufacturing's Lab Dewar (Liquid Nitrogen Containers) are able to store liquid nitrogen for long periods under static conditions. They are made of high-strength aluminum alloy structure and fiber glass reinforced plastic. This allows our Lab Dewar's to be light in weight, high in strength, have a long holding time of liquid nitrogen, and they are economical to assure safe use.

Feature

- Top can be locked with supplied padlock



Shown is the top of the Liquid Nitrogen container that organizes the specimens holders

Liquid Nitrogen Container

Pt #	Description	Sugg. Retail	5+ Price
LAB-D6	Lab Dewar – 6 Liter	525.00	294.00
LAB-D10	Lab Dewar – 10 Liter	583.00	367.25
LAB-D30	Lab Dewar – 30 Liter	903.00	656.45



Dipper Specimen Holder

MODEL LAB DEWAR 6

Capacity 6 Liters

UNIT DIMENSIONS

Opening diameter (in/mm)	2 (50)
Outside diameter (in/mm)	10.875 (276)
Overall height (in/mm)	16.375 (416)
Empty weight (lbs/kg)	10.8 (4.9)
Full weight (lbs/kg)	21.6 (9.8)
Preservation days of static liquid nitrogen (days)	
Qualified product	45
Best quality	60
Daily evaporation capacity of liquid nitrogen (ltrs/day)	
Qualified product	0.13
Best quality	0.10
Outside diameter of dipper(s) (in/mm)	1.5 (38)
The number of dipper(s)	3-6
Straw holding capacity of each dipper(s)	
0.25ml	298
0.5 ml	132



Pt # LAB-D6

MODEL LAB DEWAR 30

Capacity 31.5 Liters

UNIT DIMENSIONS

Opening diameter (in/mm)	2 (50)
Outside diameter (in/mm)	17.5625 (446)
Overall height (in/mm)	26.375 (670)
Empty weight (lbs/kg)	30.9 (14)
Full weight (lbs/kg)	87.1 (39.5)
Preservation days of static liquid nitrogen (days)	
Qualified product	225
Best quality	280
Daily evaporation capacity of liquid nitrogen (ltrs/day)	
Qualified product	0.14
Best quality	0.11
Outside diameter of dipper(s) (in/mm)	1.5 (38)
The number of dipper(s)	3-6
Straw holding capacity of each dipper(s)	
0.25ml	298
0.5 ml	132



Pt # LAB-D30

MODEL LAB DEWAR 10

Capacity 10 Liters

UNIT DIMENSIONS

Opening diameter (in/mm)	2 (50)
Outside diameter (in/mm)	10.875 (276)
Overall height (in/mm)	20.875 (530)
Empty weight (lbs/kg)	11 (5)
Full weight (lbs/kg)	28.7 (13)
Preservation days of static liquid nitrogen (days)	
Qualified product	75
Best quality	90
Daily evaporation capacity of liquid nitrogen (ltrs/day)	
Qualified product	0.13
Best quality	0.11
Outside diameter of dipper(s) (in/mm)	1.5 (38)
The number of dipper(s)	3-6
Straw holding capacity of each dipper(s)	
0.25ml	298
0.5 ml	132



PT # LAB-D10

**Buy 10 or more
& Receive
Custom Silkscreening
on Insulation Cover**

Example

**FOR REFILL CALL
Your Company Name & Phone #**

Level Gauges With and Without Switches for Tank Level Applications

Gauge Key Features

- 500 PSIG Working Pressure
- Brass Body, SS Metal Internals, Viton® Seals
- Dual Top and Bottom Connections 1/4" FNPT Connections
- +/- 1% Full Scale Accuracy
- 6" Round Dial with Black Background and White Numbers and Lettering

Proof Pressure

Two times working pressure at ambient temperatures

Temperature Limits

-40°F (-40°C) to 200°F (93°F)

Standards

ASME B1.20.1
ASME B40.100
CSA-C22.2 No. 14
UL Std. No. 50
NEMA Std. No. 250
SAE J514



* Picture shown with Switch

Cryo Liquid Level Indicator Gauge 1/4" Female Connection

RMI Part #	Description
CLIG14B-6D0-60H2O	1/4" F Con 0-60" H2O
CLIG14B-6D0-100H2O	1/4" F Con 0-100" H2O
CLIG14B-6D0-150H2O	1/4" F Con 0-150" H2O
CLIG14B-6D0-200H2O	1/4" F Con 0-200" H2O
CLIG14B-6D0-300H2O	1/4" F Con 0-300" H2O
CLIG14B-6D0-400H2O	1/4" F Con 0-400" H2O
CLIG14B-6D0-500H2O	1/4" F Con 0-500" H2O

Cryo Liquid Level Indicator Gauge – Oxygen Cleaned 1/4" Female Connection

RMI Part #	Description
CLIG14B-6D0-60H2O-OX	1/4" F Con 0-60" H2O O2 clean
CLIG14B-6D0-100H2O-OX	1/4" F Con 0-100" H2O O2 clean
CLIG14B-6D0-150H2O-OX	1/4" F Con 0-150" H2O O2 clean
CLIG14B-6D0-200H2O-OX	1/4" F Con 0-200" H2O O2 clean
CLIG14B-6D0-300H2O-OX	1/4" F Con 0-300" H2O O2 clean
CLIG14B-6D0-400H2O-OX	1/4" F Con 0-400" H2O O2 clean
CLIG14B-6D0-500H2O-OX	1/4" F Con 0-500" H2O O2 clean

Switch Flags Can Be Precisely Adjusted to Switch Set Point for Highly Visible Alarm Indications

Micro-Switch Specification

Electrical 0-80" H2O and above

- **Input Voltage:** None Required
- **Set Pointers:**
Quantity – 1
Adjustment – 3% to 100% of Full Scale
With visual set point set on decreasing pressure
- **Contact(s):** 1 SPDT
Contact Rating –
4 Amps Maximum @ 30 VDC
3 Amps Maximum @ 240 VAC
5 Amps @ 120 VAC
- **Temperature:**
Operating – -20°F to +185°F
- **Environment:**
Standard – Weather-Proof Housing NEMA 4
- **Electrical Interface:**
Standard – 18", 18 Awg., 600 V 105C
Color Coded Wire Leads 1/2" FNPT
- **Gauge Accuracy:**
2% – Including Effects of the switch
- **Switch Repeatability:**
2% Maximum

Cryo Liquid Level Indicator Gauge with 1 Micro Switch 1/4" Female Connection

RMI Part #	Description
CLIG14B-6D0-80H2O-1MSW	w/1Micro Switch 1/4" F Con 0-80" H2O
CLIG14B-6D0-100H2O-1MSW	w/1Micro Switch 1/4" F Con 0-100" H2O
CLIG14B-6D0-150H2O-1MSW	w/1Micro Switch 1/4" F Con 0-150" H2O
CLIG14B-6D0-200H2O-1MSW	w/1Micro Switch 1/4" F Con 0-200" H2O
CLIG14B-6D0-300H2O-1MSW	w/1Micro Switch 1/4" F Con 0-300" H2O
CLIG14B-6D0-400H2O-1MSW	w/1Micro Switch 1/4" F Con 0-400" H2O
CLIG14B-6D0-500H2O-1MSW	w/1Micro Switch 1/4" F Con 0-500" H2O

Cryo Liquid Level Indicator Gauge with 1 Micro Switch – Oxygen Cleaned 1/4" Female Connection

RMI Part #	Description
CLIG14B-6D0-80H2O-1MSW-OX	w/1Micro Switch 1/4" F Con 0-80" H2O O2 clean
CLIG14B-6D0-100H2O-1MSW-OX	w/1Micro Switch 1/4" F Con 0-100" H2O O2 clean
CLIG14B-6D0-150H2O-1MSW-OX	w/1Micro Switch 1/4" F Con 0-150" H2O O2 clean
CLIG14B-6D0-200H2O-1MSW-OX	w/1Micro Switch 1/4" F Con 0-200" H2O O2 clean
CLIG14B-6D0-300H2O-1MSW-OX	w/1Micro Switch 1/4" F Con 0-300" H2O O2 clean
CLIG14B-6D0-400H2O-1MSW-OX	w/1Micro Switch 1/4" F Con 0-400" H2O O2 clean
CLIG14B-6D0-500H2O-1MSW-OX	w/1Micro Switch 1/4" F Con 0-500" H2O O2 clean



Ask us about our Complete Line of Herose Globe Valves, Gate Valves & Safety Relief Valves. Also check out our Complete Line of Meca-Inox 3 Piece Ball Valves.



CROSS

Part # FIT-X14

Cross Brass 1/4 FPT Forged

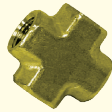

RMI RATERMANN

MANUFACTURING, INC.

RMI
Parts
for

CHART MODEL
DURA-CYL MCR
160/180/200 230/265 HP

D.O.T. 4L-292

CGA FITTINGS AND DUST CAPS
INERT ARGON/NITROGEN FITTINGS

CGA 580

Part # CGA-58038

Inert Gas 3/8" NPT

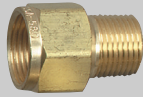

CGA 295

Part # CGA-29538

Inert Vent and Liquid 3/8" NPT



OXYGEN FITTINGS

CGA 540

Part # CGA-54038

Oxygen Gas use 3/8" NPT

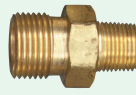

CGA 440

Part # CGA-44038

Oxygen Vent and Liquid use 3/8" NPT

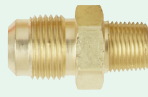

CARBON DIOXIDE FITTINGS

CGA 320

Part # CGA-32038

For CO² 3/8" NPT Used for Gas/Liquid

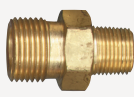

CGA 295

Part # CGA-29538

Industry Standard Used for Vent 3/8" NPT

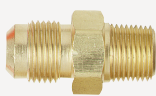

*Optional CGA Standard Vent/Liquid — CGA 622 Part # CGA-62238

INERT ARGON/NITROGEN DUST CAPS

CGA 580 DUST CAP

Part # CGA-580DC

Dust Cap for Inert Gas use CGA 580



CGA 295 DUST CAP

Part # CGA-295DC

Dust Cap for Inert Vent and Liquid



OXYGEN DUST CAPS

CGA 540 DUST CAP

Part # CGA-540DC Gas Dust Cap and Chain for CGA 540



CGA 440 DUST CAP

Part # CGA-440DC Oxygen Vent and Liquid use

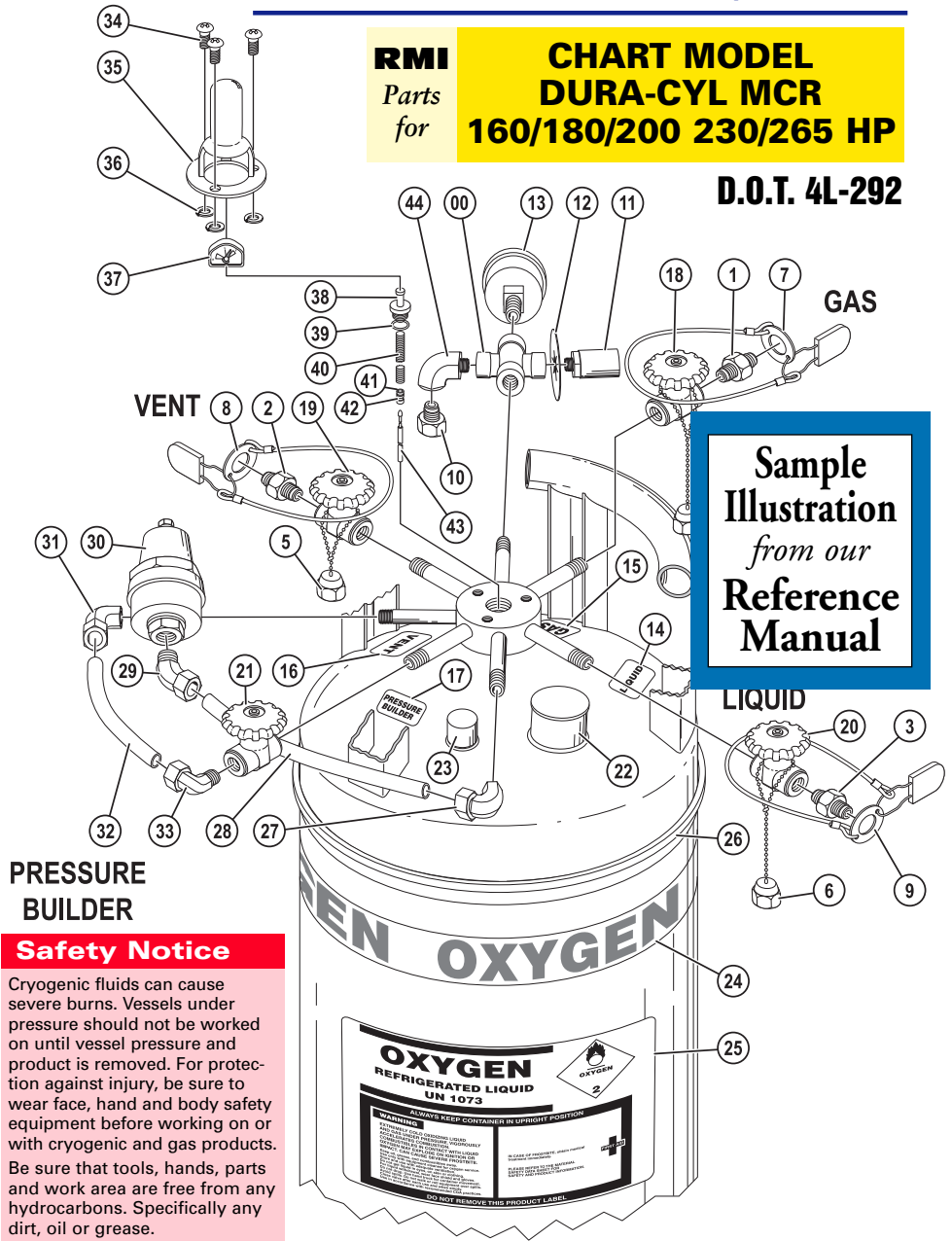

Sample Illustration from our Reference Manual

PRESSURE BUILDER

Safety Notice
Cryogenic fluids can cause severe burns. Vessels under pressure should not be worked on until vessel pressure and product is removed. For protection against injury, be sure to wear face, hand and body safety equipment before working on or with cryogenic and gas products. Be sure that tools, hands, parts and work area are free from any hydrocarbons. Specifically any dirt, oil or grease. Parts must be cleaned for oxygen service if they will be exposed to product.

Text and Illustration copyright © 2007 by Ratermann Manufacturing, Inc. All Rights Reserved.

CARBON DIOXIDE DUST CAPS

CGA 320 DUST CAP

Part # CGA-320DC Dust Cap for CO² Gas/Liquid 3/8" NPT



CGA 295 DUST CAP

Part # CGA-295DC Dust Cap for Vent



*Optional CGA Standard Vent/Liquid — CGA 622 Part # CGA-622DC

TAMPER DEVICE KITS

Oxygen – 1 Kit Part # CGP-23
Inert – 1 Kit Part # CGP-13
CO² – 1 Kit Part # CGP-25

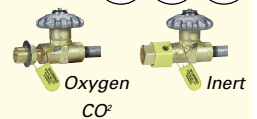

RUPTURE DISC

Part # BD-350 Rupture Disc 1/4 NPT



For All Models & Brands

Call **1-800-264-7793** for your free copy of our **Resource Catalog** or if you prefer, go to our web **www.rmiorde.com**

for

“Easy Ordering from our complete selection of expanded parts diagrams.”

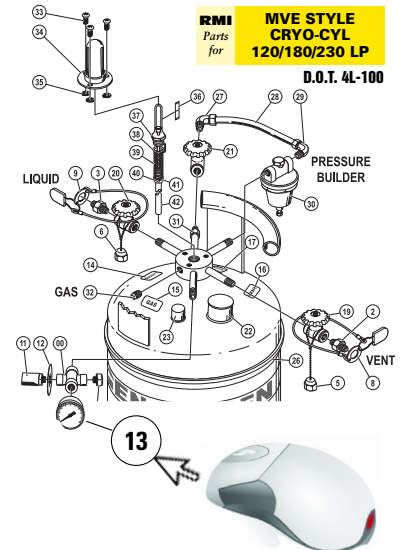

• Easy Ordering
Click on the bubble of the part number you need, and it will be automatically added to your shopping cart!

GAUGE
Part # **PG-100**
Pressure Gauge 2" Dial
0-100 PSI/BAR/KPA

ADD TO WEB STORE ORDER

RMI RATERMANN MANUFACTURING, INC.
Largest Selection of Cryogenic and Compressed Gas Equipment & Supplies

Easy Choice the Hose for your Customer Application!

Composite Gas Piping

Main Catalog Fall #7

Index

- Dewars 15-a
- 1-a
- Hose 2-a
- Cryogenic Parts 3-a
- Valves 4-a
- Fill Plant Hose 5-a

100's of Unions, Elbows, Tee's & Fittings

17-a

18-a

19-a

20-a

21-a

22-a

23-a

RATERMANN MFG., INC. 1-800-264-7793 Fax 1-800-264-7797

Web Store: RMIORDER.COM

RMI Parts for CHART MODEL DURA-CYL MCR 160/180/200 230/265 HP 1D

RELIEF VALVE 11
Part # **LPR-350**
Relief Valve Brass
1/4 NPT 350 PSI

PRESSURE RELIEF I.D. DISC 12
Part # **DS-350**
Color-coded pressure relief I.D. discs are imprinted with the appropriate pressure of safety relief.

GAUGE 13
Part # **PG-600**
Pressure Gauge 2" Dial
0-600 PSI/BAR/KPA

LABEL LIQUID 14
Part # **DL-OL**
Decal - Liquid Valve

LABEL GAS 15
Part # **DL-OG**
Decal - Gas

LABEL VENT 16
Part # **DL-OV**
Decal - Vent

LABEL PB 17
Part # **DL-OPB**
Decal - Pressure Builder Valve

GAS USE VALVE 18
Part # **VR-38F218TB-G**
Green Handle - Valve Brass
GH 3/8 FPT x 3/8 SCH 10
(VALVE REBUILD KIT Pt # **VR-RBK1**)

VENT USE VALVE 19
Part # **VR-38F218TB-S**
Silver Handle - Valve Brass
GH 3/8 FPT x 3/8 SCH 10
(VALVE REBUILD KIT Pt # **VR-RBK1**)

LIQUID USE VALVE 20
Part # **VR-38F218TB-B**
Blue Handle - Valve Brass
BH 3/8 FPT x 3/8 SCH 10
(VALVE REBUILD KIT Pt # **VR-RBK1**)

VALVE PRESSURE BUILDER 21
Part # **VR-38F38F**
Short-stem shut off valves 3/8" FNPT
(VALVE REBUILD KIT Pt # **VR-RBK1**)

CAP 22
Part # **DC-CAP**
Cap Vinyl - Plastic Blue

CAP 23
Part # **PC-MS**
Pumpout Cap

DEWAR 360° WRAP AROUND TAPE 24
Part #'s for Gas Tape:
DG-TC Carbon Dioxide
DG-TO Oxygen
DG-TV Nitrogen
DG-TA Argon

Part #'s for Medical Tape:
DG-MEDO Medical Oxygen
DG-MEDN Medical Nitrogen
DG-MEDNO Med Nitrous Oxide
DG-MEDCO2 Med Carbon Dioxide

DEWAR LABELS 25
Part #'s
DB-O Oxygen
DB-A Argon
DB-N Nitrogen
DB-CO2 CO2
DB-USP Oxygen USP
DB-NNF Nitrogen NF
DB-NOUSP Nitrous Oxide USP
DB-CO2USP Carbon Dioxide USP

LABEL BUFFER 26
Part # **LB-D160B**
Color coded bands can be used to identify pressure: Yellow for 22 PSI, Blue for 235 PSI, and gray.

ELBOW 27
Part # **EC-M3F**
Elbow Brass 90D
3/8 ODT x 1/4 FPT

TUBING 28
Part # **CCT-M4387**

ELBOW 29
Part # **FIT-90ECF38M14**
Elbow Brass 90D
3/8 ODT x 1/4 NPT

PRESSURE BUILDER ECONOMIZER COMBINATION REGULATOR 30
Part # **PBE-1-M300**

ELBOW 31
Part # **FIT-90ECF38M14**
Elbow Brass 90D
3/8 ODT x 1/4 NPT

TUBING 32
Part # **TB-COPPER**

ELBOW 33
Part # **EC-M4M**
Elbow Brass 90D
3/8 ODT x 3/8 MPT

SCREW 34
Part # **CSS-M4**

SIGHT GAUGE PROTECTOR 35
Part # **SGP-RO**

WASHERS 36
Part # **LC-M4**

CONTENTS GAUGE 37
Part #'s LL-R
LL-RN Nitrogen
LL-RO Oxygen
LL-RA Argon
LL-RCD CO2
LL-RNO N2O

PLUG 38
Part # **FIT-PLUGKNRC-2**

O-RING 39
Part # **LL-OS-CL-OR**

SPRING 40
Part # **RC-SPRING**

COLLAR 41
Part # **RC-SC9/32ID**

SCREW 42
Part # **SG-SCREW**

FLOAT ROD 43
Part # **FR-M-230**
Part # **FR-M-180**
Part # **FR-M-160**

ELBOW 44
Part # **EC-14M**
Elbow Brass 90D
1/4 NPT x 1/4 FPT

MEDICAL CGA FITTINGS
TAMPER PROOF DEVICE
This system cannot be removed without rendering the CGA outlet connection unusable.

INERT
1 Part # **TPG-580** CGA 580 (Gas use)
2 3 Part # **TPG-295** CGA 295 (Vent & Liquid use)

OXYGEN
1 Part # **TPG-540** CGA 540 (Gas use)
2 3 Part # **TPG-440** CGA 440 (Vent & Liquid use)

CARBON DIOXIDE
1 Part # **TPG-320** CGA 320 (CO2 Gas)
2 3 Part # **TPG-622** CGA 622 (Vent & Liquid use)

For 80 Cubic Feet through 330 Cubic Feet



TRIANGULAR COLLARS NON-IMPRINTED For 80 cu. ft. through 330 cu. ft.



ROUND COLLARS NON-IMPRINTED For 80 cu. ft. through 330 cu. ft.



SQUARE COLLARS NON-IMPRINTED For 80 cu. ft. through 330 cu. ft.



CUSTOMER OWNED IMPRINTED COLLARS For 80 cu. ft. through 330 cu. ft.

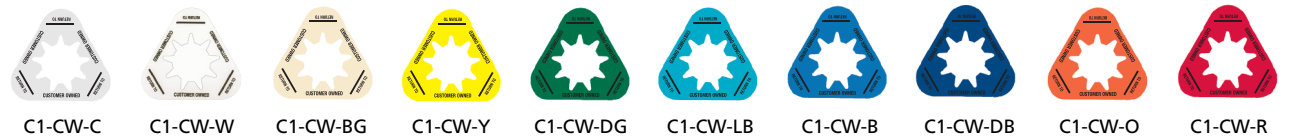

NON-CAP STYLE NON-IMPRINTED COLLARS Room to write 50 cu. ft. through 20 cu. ft.

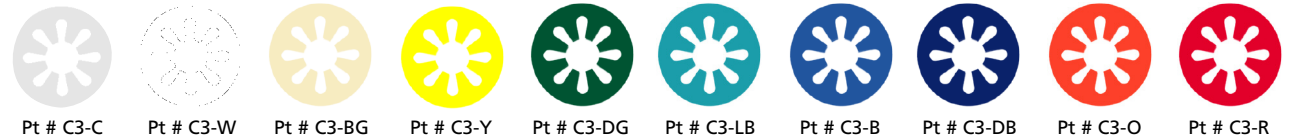

NON-CAP STYLE NON-IMPRINTED COLLARS Room to write 50 cu. ft. through 20 cu. ft.

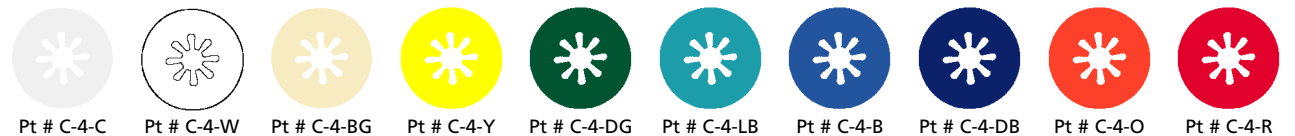

NON-CAP STYLE NON-IMPRINTED COLLARS For Medical-Yoke, Mc & B Acetylene

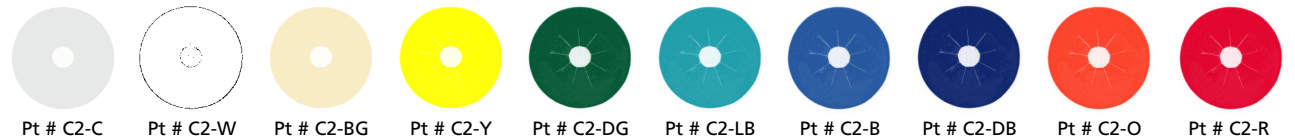

ACETYLENE CYLINDER COLLARS NON-IMPRINTED

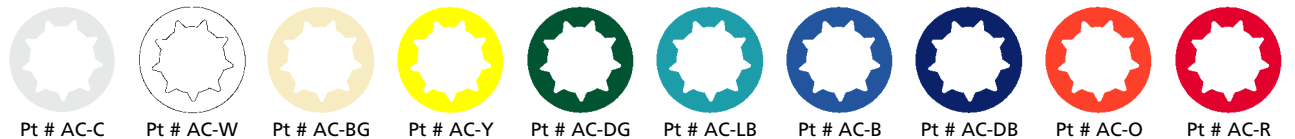

PRE-PRINTED CYLINDER MANAGEMENT LARGE CYLINDER I.D. COLLARS

For 80 cu. ft. through 330 cu. ft.



Florescent Orange Hot Pink Lime Green Pink Gold Silver Copper

Special Colors Also Available



Pt # C1-P Pt # C1-BR Pt # C1-GY Pt # C1-BL Pt # C1-FO Pt # C1-HP Pt # C1-LG Pt # C1-PK Pt # C1-GOLD Pt # C1-SI Pt # C1-CP

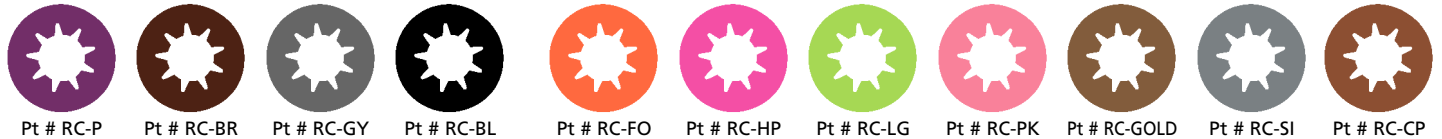

Pt # RC-P Pt # RC-BR Pt # RC-GY Pt # RC-BL Pt # RC-FO Pt # RC-HP Pt # RC-LG Pt # RC-PK Pt # RC-GOLD Pt # RC-SI Pt # RC-CP

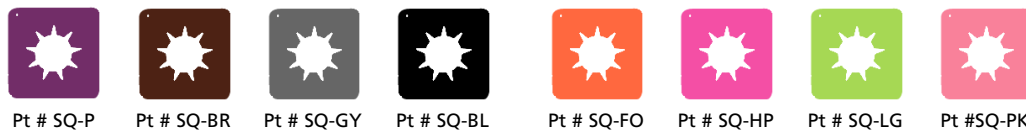

Pt # SQ-P Pt # SQ-BR Pt # SQ-GY Pt # SQ-BL Pt # SQ-FO Pt # SQ-HP Pt # SQ-LG Pt # SQ-PK

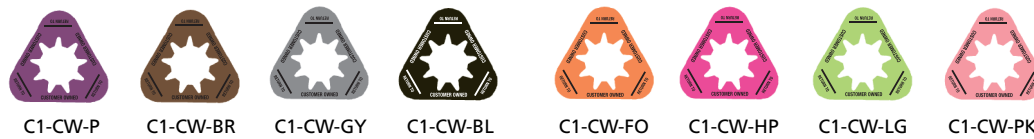

C1-CW-P C1-CW-BR C1-CW-GY C1-CW-BL C1-CW-FO C1-CW-HP C1-CW-LG C1-CW-PK

Collars are Available in Packs of 50 and for Smaller Applications Packs of 10

To order package quantity add to collar part #
for 50 pack add PK50
10 pack add PK10

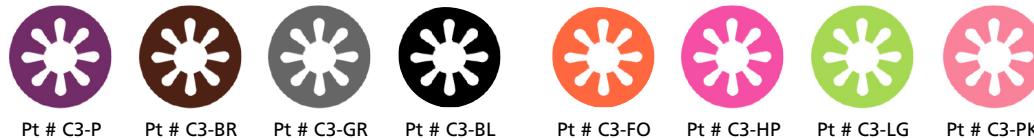

Pt # C3-P Pt # C3-BR Pt # C3-GR Pt # C3-BL Pt # C3-FO Pt # C3-HP Pt # C3-LG Pt # C3-PK



Pt # C-4-P Pt # C-4-BR Pt # C-4-GR Pt # C-4-BL Pt # C-4-FO Pt # C-4-HP Pt # C-4-LG Pt # C-4-PK Pt # C-4-GOLD Pt # C-4-SI Pt # C-4-CP

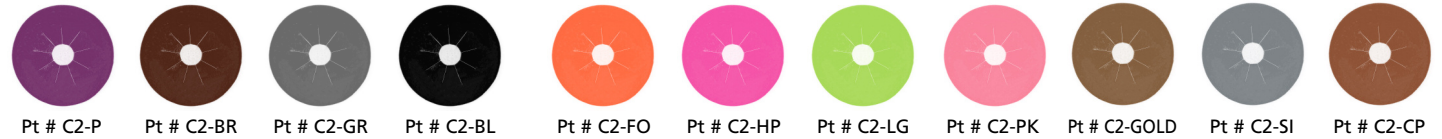

Pt # C2-P Pt # C2-BR Pt # C2-GR Pt # C2-BL Pt # C2-FO Pt # C2-HP Pt # C2-LG Pt # C2-PK Pt # C2-GOLD Pt # C2-SI Pt # C2-CP

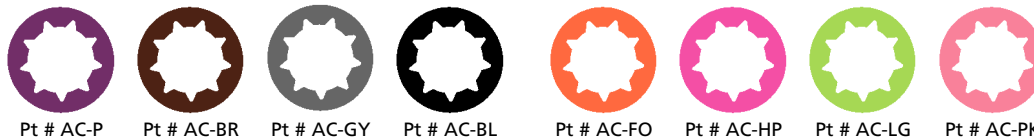

Pt # AC-P Pt # AC-BR Pt # AC-GY Pt # AC-BL Pt # AC-FO Pt # AC-HP Pt # AC-LG Pt # AC-PK

PRE-PRINTED CYLINDER MANAGEMENT SMALL CYLINDER I.D. COLLARS



For Mc, B & Medical Valve



Pt # C2-OO



Pt # C2-LR



Pt # C2-SB



Pt # C2-RV



Pt # C2-RQ



Pt # C2-CW

All Standard Colors Available

See page 10
To Custom Imprint Your Collars

Develop a Customized Cylinder Management System for Your Organization

Use for

- Job Sites
- Cylinder Processing

Choose Imprint

1. Choose Collar Color & Shape

With same imprint and color ink, you can mix and match different color collars at no extra charge.

2. Choose Imprint for Collar

Light material – dark print
Dark material – light print



Available Collar Colors

Color Prefix

C	W	Special Colors There is an additional Charge of 20¢ for Special Colors per Collar		
BG	Y			
DG	LB			
B	DB			
O	R			
P	BR		FO	HP
GY	BL		LG	PK

Oxygen Compatible OC Three PTFE Paste Joint & Thread Sealer



Solutions for critical and demanding applications where no flammability, compatibility with oxygen and resistance to aggressive chemicals are essential.

OC Three PTFE Paste Joint and Thread Sealer is an aqueous based PTFE formulation. It is a homogenous white paste that penetrates thread convolutions more effectively, and more safely, than PTFE tape. Tested, approved and certified by BAM for gaseous and liquid oxygen service. Use in extreme temperatures (-400° F to +500° F) and Mid Vacuum specifications to 10-3 Torr.

OC Three is especially capable for sealing oxygen and acetylene cylinder valves. Easy to apply from its 4 oz. (113.4 gram) squeeze tube with extended nipple and resealing cap.

A superior PTFE thread sealant paste that contains these optimal properties:

- Water Soluble
- Anti-Corrosive
- Chemically Inert
- Non-Toxic
- Non-Flammable
- Non-Migrating
- Odorless

OC Three is compatible with many aggressive chemicals including:

- Acetylene
- Carbon dioxide
- Helium
- Hydrogen
- Oxygen (liquid & gaseous)
- plus many more

OC Three PTFE Paste

Pt #	Description
OXY-OC3-4OZ	OC Three PTFE Paste - 4 oz. Squeeze Tube
OXY-OC3-650G	OC Three PTFE Paste - 650 Gram Jar

Oxygen Compatible OC Five Paste and OC Seven Grease

Solutions for critical and demanding applications where no flammability, compatibility with oxygen and resistance to aggressive chemicals are essential.

OC Five Paste and OC Seven Grease are blended formulations consisting of PTFE particles and Halocarbon® oil, producing a superior sealant that is chemically inert and environmentally safe. Both products have been tested and certified by BAM for gaseous and liquid oxygen service.

Cost effective for:

- Liquid Oxygen
- Liquid Nitrogen
- Cryo & Vacuum Applications



Oxygen Compatible OC Five Paste and OC Seven Grease

Pt #	Description
OXY-OC5-2OZ	OC Five Oxygen Compatible Paste - 2 oz.
OXY-OC5-16OZ	OC Five Oxygen Compatible Paste - 16 oz.
OXY-OC7-2OZ	OC Seven Oxygen Compatible Paste - 2 oz.
OXY-OC7-16OZ	OC Seven Oxygen Compatible Paste - 16 oz.
OXY-OC7-CART	OC Seven Oxygen Compatible Paste in a Cartridge

- Grease Gun H.D.



Pt # CART-GUN

See Our Main Catalog or Web Site for Different Collar Styles or Give us a Call



Pt # C1-B-C1

Imprint Style

Part #	1,000	500	250
C1-_-CI	\$1.71	\$2.12	\$2.93

Enter Color Here

To order, choose color of collar. Use part number listed to specify color, and add imprint style part number.

Price includes one color printing and collar.

One-time plate charge: \$95.00

Custom Print Collar + or - 15% Production Run.

All custom imprinted products are manufactured and shipped from the West Coast facility.

OxyTOTE Portable Oxygen System

The OxyTOTE™ “All-In-One” regulator is perfect for transporting and dispensing oxygen in one easy-to-use package. With Western’s innovative concept and design, the OxyTOTE regulator provides optimal performance in a click-style regulator by delivering the liter flow needed without the time and frustration of matching regulators and cylinders. This unique “All-In-One” design is a safe, easy-to-use and cost-effective method of distributing oxygen. The OxyTOTE, like all Western products, meets exacting standards for performance and reliability. Sold separately or attached to cylinder.

Features

- Regulator and cylinder valve combined into one unit
- User can initiate flow in one easy step
- Compact design with all brass body
- Maximum rated inlet pressure 3000 psi
- 1-1/2" diameter gauge
- Transfill through CGA-540 port
- Filtration throughout for maximum safety
- Integral reseating relief valve protects against over-pressurization
- Protective shroud ensures safety and lasting performance
- Hose barb outlet is standard
- Unit can be ordered with or without DISS (demand valve)

Durable cover protects regulator & valve assembly.

SureClick™ feature reduces the risk of dialing the flow selector between click settings, making it easier for clinicians to dial in and secure oxygen flow.

All-In-One Brass regulator assembly incorporates post valve and flow control device into a single unit. Units are quickly refilled through a CGA-540 fill port on reverse side.

Easy-to-read 1-1/2" cylinder contents gauge.

Permanent assembly onto a lightweight aluminum or steel cylinder.



Built in handle for portability.

On/Off flow control knob with adjustable flow rates of .5 - 25 liters per minute.

Tapered hose barb for attaching cannula. Barb outlet is recessed for protection against damage.

5 Year Warranty

On/Off valve maximizes regulator life by minimizing its exposure to cylinder pressure.

OxyTOTE Regulator Specifications (OxyTOTE Regulator Only)

Size	7-3/4" x 4-1/2"
Weight	2 lbs. 10 oz.
OxyTOTE Flow (LPM)	1/2, 1, 1-1/2, 2, 3, 4, 6, 8, 10, 15, 25, AUX

OxyTOTE Regulator Specifications (OxyTOTE Regulator Only)

Part #	Description	Sale Price
WST-MTR-500	OxyTOTE Head only for aluminum cylinder – Hose Barb Only	105.23
WST-MTR-510	OxyTOTE Head only for steel cylinder – Hose Barb Only	105.23
WST-MTR-600	OxyTOTE Head only for aluminum cyl. – Hose Barb & DISS* Outlet	115.76
WST-MTR-610	OxyTOTE Head only for steel cylinder – Hose Barb & DISS* Outlet	115.76

For Every 25 Purchased Receive One FREE

Special Pricing

For Every 25 Purchased Receive One FREE

Special Pricing

- WST-MTR-500 Series is MR conditional for use outside the bore of an MR machine under the following conditions: Static magnetic field of 3.0 Tesla or less; Spatial gradient field of 3.3 Tesla / meter or less.

Part #	Description	Sale Price
WST-MTS-501	OxyTOTE on C aluminum cylinder - Hose Barb Only	141.72
WST-MTS-502	OxyTOTE on D aluminum cylinder – Hose Barb Only	141.72
WST-MTS-503	OxyTOTE on E aluminum cylinder – Hose Barb Only	142.07
WST-MTS-505	OxyTOTE on M6A aluminum cylinder – Hose Barb Only	141.72
WST-MTS-601	OxyTOTE on C aluminum cylinder - Hose Barb & DISS* Outlet	161.67
WST-MTS-602	OxyTOTE on D aluminum cylinder – Hose Barb & DISS* Outlet	161.67
WST-MTS-603	OxyTOTE on E aluminum cylinder – Hose Barb & DISS* Outlet	152.60
WST-MTS-605	OxyTOTE on M6A aluminum cylinder – Hose Barb & DISS* Outlet	161.67

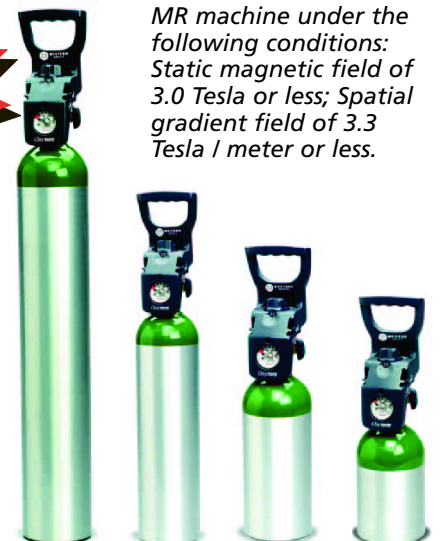

Pt # WST-MTS-503 Pt # WST-MTS-502 Pt # WST-MTS-501 Pt # WST-MTS-505

*DISS outlet is Auxiliary port (demand valve). Outlet pressure 50 psi. Hose barb for use in controlled flow applications (cannot be used simultaneously with DISS).

High Purity Regulators

Brass Barstock Regulator

Single or Two Stage

Recommended for gas purity levels of Grade 5.0 (99.999) and higher.



Single Stage cylinder regulators available in brass or chrome plated brass barstock for pressure control of non corrosive gases when pressure rise is not critical.

Two Stage cylinder regulators available in brass or chrome plated brass barstock for constant delivery pressure from full to near empty cylinder conditions.

Single Stage

Pt # Brass	Description
BSRHPU-1B-580-125	High Purity Barstock Regulator, Single Stage, Brass, CGA 580, 0-125 PSIG
BSRHPU-1B-540-125	High Purity Barstock Regulator, Single Stage, Brass, CGA 540, 0-125 PSIG
Pt # Chrome Plated	Description
BSRHPU-1CH-580-125	High Purity Barstock Regulator, Single Stage, Chrome Plated, CGA 580, 0-125 PSIG
BSRHPU-1CH-540-125	High Purity Barstock Regulator, Single Stage, Chrome Plated, CGA 540, 0-125 PSIG

Two Stage

Pt # Brass	Description
BSRHPU-2B-580-125	High Purity Barstock Regulator, Two Stage, Brass, CGA 580, 0-125 PSIG
BSRHPU-2B-540-125	High Purity Barstock Regulator, Two Stage, Brass, CGA 540, 0-125 PSIG
Pt # Chrome Plated	Description
BSRHPU-2CH-580-125	High Purity Barstock Regulator, Two Stage, Chrome Plated, CGA 580, 0-125 PSIG
BSRHPU-2CH-540-125	High Purity Barstock Regulator, Two Stage, Chrome Plated, CGA 540, 0-125 PSIG

Stainless Steel Barstock Regulator

Single or Two Stage

Recommended for corrosive gas or purity levels of Grade 6.0 (99.999) and higher.



Single Stage stainless steel cylinder regulator for applications where a slight rise in delivery pressure from full to empty cylinder can be tolerated.

Two Stage stainless steel cylinder regulator for constant delivery pressure from full to near empty cylinder conditions.

Single Stage

Pt # Stainless Steel	Description
BSRHPU-1SS-580-125	High Purity Barstock Regulator, Single Stage, Stainless Steel, CGA 580, 0-125 PSIG
BSRHPU-1SS-540-125	High Purity Barstock Regulator, Single Stage, Stainless Steel, CGA 540, 0-125 PSIG

Two Stage

Pt # Stainless Steel	Description
BSRHPU-2SS-580-125	High Purity Barstock Regulator, Two Stage, Stainless Steel, CGA 580, 0-125 PSIG
BSRHPU-2SS-540-125	High Purity Barstock Regulator, Two Stage, Stainless Steel, CGA 540, 0-125 PSIG

Medical Regulator



Regulator

Click Stop Regulator CGA-870



Part #	Description	1+ Price	25+ Price
REG-540-0-25-LPM-DISS	Medical Regulator, CGA 540, 0-25 Liters per minute, w/DISS Outlet	22.72	19.23
REG-870-0-15-LPM	Medical Regulator with Barb, CGA 870, 0-15 LPM	20.89	17.69
RG870-0-8LTR	Regulator with Barb, CGA 870, 0-8 LPM	20.89	17.69

Other CGA and Delivery Pressures are available. Give us a call, we are happy to help!

Paint Ball 2 Lever Fill Station

Fill stations are designed to fill your constant air (C.A.) bottles (3 1/2 oz., 7 oz., 10 oz. and 20 oz. bottles) with liquid carbon dioxide (CO2). Please note that the CO2 is liquid; the bottles are designed to hold the designated amount in liquid form. If you do not use a bulk tank with a siphon tube, you will probably transfer gas CO2, and this will change the weight of the tank. The bottles are designed to accommodate approximately 65% of their volume in liquid CO2. The remaining space is unfilled, allowing for the expansion of the CO2 as temperature convert into gas.

WARNING:

- Always use a scale to transfer the correct volume of CO2.
- DO NOT overfill your C.A. bottle to try for a few more shots.
- Secure your bulk tank so it will not fall/bump into other objects.

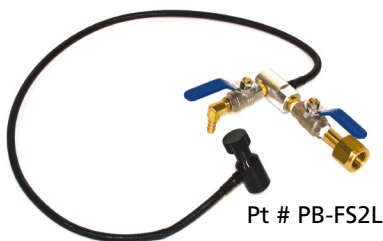

Pt # PB-FS2L

Paint Ball Fill Station

Pt #	Description
PB-FS2L	Paint Ball 2 Lever Fill Station



Excellent Hose Choice for your Customer
Needing No Permeation in the Hose
Excellent for Laser Gas Applications

**Hydrogen, Helium
& Specialty Gas
Applications**

*Hydrogen, Helium
and Specialty Gas
Application up to
Working Pressure
of 4,500 psi*

Ratermann's Type 316L stainless steel innercore, double braided hose is extremely flexible and durable. The all-stainless steel, all-welded construction makes this hose ideal for Hydrogen and Helium. Extreme high pressure design.

Stamped with 4,500 PSIG MAWP, and month/year of manufacturer.



Hoses for Above Gases



Photo shown with armour

Female to Female

Standard Hose

Hose Length	Part #
24"	FPS-45P24F14
36"	FPS-45P36F14
48"	FPS-45P48F14

1/4" F x 1/4" M hoses available

**With Armor Casing
Anti-Kink, Anti-Whip**

Hose Length	Part #
24"	FPS-A-45P24F14
36"	FPS-A-45P36F14
48"	FPS-A-45P48F14

72" & 10' hoses available



For the Atmospheric Gas, Cryogenic & Specialty Gas Industries

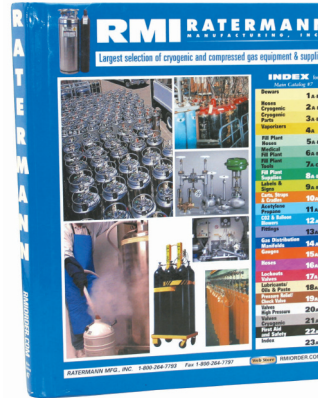

Also Available
**Our Hard
Back Printed
Hose Section
Catalog**

includes complete line of

- Cryogenic • Bulk • Fittings
- High Pressure & Medical Gas Hoses
- Specialty Hose Application

**Call for your
FREE copy or
E-mail**

sales@rmimfg.com

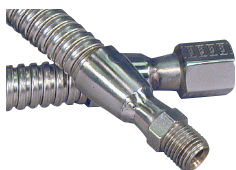



Introducing our **NEW** website

The **HOSE BUILDER**

Using **The Hose Builder** you will be able to Build your Hose in just **4 Easy Steps!**

Before you begin to Build Your Hose, **CHOOSE** your Gas Application. **NEXT**

<p>Step 1</p> <p>Choose Hose Type for your Application Example: <input checked="" type="checkbox"/> 3,000 PSI</p>	<p>Step 2</p> <p>Choose Hose Casing Example:  <input checked="" type="checkbox"/> Armored</p>	<p>Step 3</p> <p>Choose Hose Length in Inches Example: <input checked="" type="checkbox"/> 48 inches</p>	<p>Step 4</p> <p>Choose Hose Inlet & Outlet Example:  <input checked="" type="checkbox"/> 3/8" Male NPT</p>
---	--	--	--

**Fast
&
Easy**

to order the
**Hose
&
Fittings**
You Need!

Cylinder Carts & Utility Wagons

■ The Ratermann's Medical Carts are offered in a variety of sizes and styles. Painted in our characteristic green, these carts accommodate 1, 2, 4, 6, 12, 24, 36 and 50 'D' and 'E' cylinders. All 1 to 6 cylinder carts come with eight-inch semi-pneumatic wheels. Larger capacity carts are equipped with four-inch polyurethane lockable casters.



Pt # CSC-MDE12S



Pt # CSC-MDE12HD

Special Pricing

■ The CSC-55216FW is designed for heavy-duty construction projects. CSC-55216FW has two Perma-Clamps and a lifting eye, a 6" x 6" x 24" Lockable tool-boxes and multi-axle brackets. If you are using an 8 1/2" diameter acetylene, please add "-SM" to the part number. This will aid in sending the proper Perma-Clamps. Ratermann's firewall carts meet current OSHA requirements.



Pt # CSC-55216FW

Pt #	Description	1+ Price	6+ Price
CSC-MDE12S	Medical D & E Stationary Cart holds 12 Cylinders	170.50	138.83
CSC-MDE12HD	Medical D & E Heavy Duty Cart holds 12 Cylinders	278.04	226.49
CSC-MDE24	Medical D & E Cart holds 24 Cylinders	306.50	249.83
CSC-55216FW	Acetylene Cart with Firewall	551.61	450.08
CSC-UWT	Utility Wagon with Top and Etracks	551.90	496.71
CSC-UW	Utility Wagon	370.91	333.82



Pt # CSC-UW



Pt # CSC-MDE24

■ The Ratermann Manufacturing, Inc. Medical Series is offered in a variety of sizes and styles. Painted in our characteristic green, these carts accommodate one, two, four, six, 12 and 24 'D' and 'E' cylinders. Larger capacity carts such as CSC-MDE24 are equipped with four-inch polyurethane lockable casters. They can also be ordered stationary by adding "S" to the end of the part number.



Pt # CSC-UWT

■ The Utility Wagon will carry 50 or more D and E size cylinders safely and securely. Straps are included for added security. CSC-UW can hold a variety of cylinders.

Part #	Wheel Type	Wheel	Cyl. Cap	H	W	L	Weight
CSC-MDE12S	stand	-	D/E	21"	16 1/2"	23 1/2"	25 lbs.
CSC-MDE12HD	4" polyurethane	CSC-WH-23, CSC-WH-24	D/E	39"	16 1/2"	23 1/2"	49 lbs.
CSC-MDE24	4" polyurethane	CSC-WH-23, CSC-WH-24	D/E	39"	21 1/2"	33 1/2"	63 lbs.
CSC-55216FW	16" pneu. 4.80 x 4	CSC-WH-11	13" x 26"	24"	62"	38"	143 lbs.
CSC-UW	-	-	-	35 5/8"	23 1/2"	38 1/2"	98 lbs.

Cylinder 6 & 12 & 16 Pack Cradles

**Palletize
Your
Operation**



16 Cradle Pallet Packs

Part # Powder Coated	Sale Price	Description
CRS-FL16PK-346FP	1,593.97	16 Forklift CGA 346 Air with Flex Pigtail
CRS-FL16PK-540FP	1,593.97	16 Forklift CGA 540 Oxygen with Flex Pigtail
CRS-FL16PK-580FP	1,593.97	16 Forklift CGA 580 Argon, Nitrogen with Flex Pigtail

Rigid and TSCZEL Pigtails are also available for an additional \$75.00.
To order replace "FP" in the part number with "RG" for Rigid or "TZ" for TSCZEL

Pt # CRS-FL16PK



Pt # CRS-FL6PK

Photo above shows optional version with six casters. Part #'s below are for 4 caster versions. To order 6 caster versions, add CAS6 at the end of the 4 caster Part #.



Pt # CRS-C12PK

(Side view of top of cradle forklift tube)

Customize Your Name Into Cradle

Sample of 2" Custom Cut Out lettering and numbers available for easy identification of your cradle in the field.

PROMO

**Buy 5 or More
6 or 12 Packs
and Receive
Custom Cut Out
in Top of Cradle
Forklift Tube
at
NO CHARGE**

Please note: Hydrogen and Helium available, call for part #.



Forklift – 6 Pack Cradle

On Casters – 6 Pack Cradle

Pt # Powder Coated	Sale Price	Pt # Powder Coated	Sale Price	Description
CRS-FL6PK-346FP	661.87	CRS-C6PK-346FP	737.02	CGA 346 Air w/ Flex Pigtail
CRS-FL6PK-540FP	661.87	CRS-C6PK-540FP	737.02	CGA 540 Oxygen w/ Flex Pigtail
CRS-FL6PK-580FP	661.87	CRS-C6PK-580FP	737.02	CGA 580 Argon, Nitrogen w/ Flex Pigtail

Rigid and TSCZEL Pigtails are also available for an additional \$65.00.
To order replace "FP" in the part number with "RG" for Rigid or "TZ" for TSCZEL.

Forklift – 12 Pack Cradle

On Casters – 12 Pack Cradle

Pt # Powder Coated	Sale Price	Pt # Powder Coated	Sale Price	Description
CRS-FL12PK-346FP	940.88	CRS-C12PK-346FP	989.29	CGA 346 Air w/ Flex Pigtail
CRS-FL12PK-540FP	940.88	CRS-C12PK-540FP	989.29	CGA 540 Oxygen w/ Flex Pigtail
CRS-FL12PK-580FP	940.88	CRS-C12PK-580FP	989.29	CGA 580 Argon, Nitrogen w/ Flex Pigtail

Rigid and TSCZEL Pigtails are also available for an additional \$70.00.
To order replace "FP" in the part number with "RG" for Rigid or "TZ" for TSCZEL.

Some products have steel surcharges

Locations

• New Jersey • Tennessee • California

Payment Center

601 Pinnacle Place
Livermore, California 94550

We also accept MasterCard, VISA,
American Express and Discover.



**Promotion
on
OxyTOTE
Portable
Oxygen
System**

OxyTOTE
see page 11



NEW

Utility
Cart
see page
14



Pt # CSC-UWT

Propane Quick Connect Fill Tool



Quick Connect
see page 2

- OPD Propane Cylinder Quick Fill
- Bulk Propane Quick Fill



Pt # QF-PRO-OPD

**Auto Changeover
Manifold Controls
High Pressure**



Mighty Max 2 Cylinder Automatic Changeover Manifold

These automatic changeover controls are designed to deliver an uninterrupted supply of gas from high pressure and portable cryogenic cylinders, providing automatic switchover from "service" to "reserve" bank. They do the work of much larger and more costly automatic changeover controls at a fraction of the cost and size. The control unit is very compact at 3" wide x 5.5" high x 1.25" deep. All units are shipped complete with the proper pigtailed and CGA tee connections for the indicated gas service. A customer/distributor supplied cylinder regulator is required for delivery pressure adjustment. Control indicators include: individual bank pressure gauges and pop out indicators that show which cylinder is in use and changeover status. The H series provides fully automatic changeover for high pressure cylinders, switching at 200 psig. The LH series switches over a 100 psig and is designed for use with low pressure cryogenic cylinders, high pressure cylinders or a combination of the two.

Pt #	Description	Sale Price
MAN-ACMC-3202-H	Automatic Changeover CGA 320, 2 Cyl.	374.42
MAN-ACMC-5402-H	Automatic Changeover CGA 540, 2 Cyl.	374.42
MAN-ACMC-5802-H	Automatic Changeover CGA 580, 2 Cyl.	374.42



**Status
Tag**

Be Safe!
Always
Secure
Cylinders
wording on
your Status
Tag



Be Safe!
Always Secure Cylinders Status Tag

Pt #	Descr	Pack 100	1-4	5+
CB-WCSY	Status Tag	14.15		12.85

**Family
of Dewars**

- Product in stock
- No steel surcharge
- Free Freight with 5 or more tanks
- Easy lease program